



# Katalog Mebli

# Furniture Catalogue





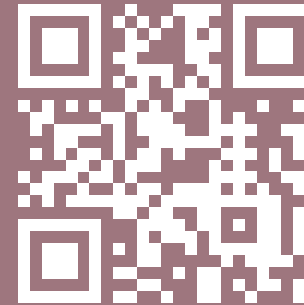

Sprawdź więcej na **eltap.pl**





zeskanuj kod i zobacz nowe modele

-  polub nas na Facebooku
-  zaobserwuj nas na Instagramie
-  subskrybuj nasz kanał na YouTube

Check out more at **eltap.com**



scan the code and check out the new models

-  like us on Facebook
-  follow us on Instagramie
-  subscribe to our YouTube channel



# spis treści

# table of contents

## Narożniki | Corners

12	Noble
14	Larde
16	Laurence
18	Bretan
20	Larco
22	Silva
24	Cassara
26	Bonito
28	Neviro
30	Silla
32	Torrense
34	Theodore
36	Vertizo
38	Montez
40	Louis
42	Grayson
44	Lacante
46	Lanvin
48	Bonett
50	Anton
52	Thiago
54	Josette
55	Mariall
56	Giovanni
57	Loreto
58	Federico
59	Letto
60	Eduardo
61	Eridano
62	Lorelle
63	Roxi
64	Ricardo
65	Rodrigo
66	Escada

## Sofy | Sofas

67	Kairos
68	Solange
69	Sorento
70	Evanell
71	Trevisco
72	Vento
73	Verso
74	Asgard L
75	Asgard U
76	Armando
77	Damario
82	Aros 2F
83	Asgard 3F
84	Dalia
85	Elise
86	Revi
87	Silla
88	Silva
89	Torrense
90	Lazaro
91	Megis
92	Bellis
93	Selene
94	Laurence

## Fotele, szezlongi, pufy

Armchairs, chaise  
longues and pouffes

98	Aros
98	Arti
99	Asgard
100	Lazaro
100	Megis
101	Dalia
102	Silva
103	Torrense
103	Vivien
104	Doro
104	Taco
105	Loren
106	Asgard
106	Bero
107	Kelim
107	Lara
108	Lazaro
108	Linsy
109	Lorelle
109	Monty
110	Megis
110	Nolla
111	Selene
111	Silla
112	Silva
113	Sofia
113	Torrense

## Stoliki | Tables

118	Cloue
118	Linze
119	Merala
119	Verto
120	Clar
120	Fresco
121	Gavino
121	Lupe
122	Moss
122	Marlo
123	Nevio
123	Torvi
124	Vigo
124	Vince

## Lustra | Mirrors

126	Arizona
127	Verona
128	Aruba
128	Medina
129	Vasto

## Meble twarde Storage furniture

130	Lanzzi
134	Avorio





tkanina do zadań  
specjalnych

fabric for special  
tasks

W dzisiejszych czasach tkaniny obiciowe pełnią funkcję nie tylko dekoracyjną. Obecne tkaniny to materiały do zadań specjalnych... łatwe do czyszczenia, wodoodporne, plamoodporne, ekologiczne, a do tego piękne i w tysiącach kolorów.

Welur, szenil, plecionka to tylko niektóre rodzaje z tkanin obecnie dostępnych na rynku. Każda z nich ma inną strukturę, miękkość oraz wygląd zewnętrzny. Cechy te są istotne z punktu widzenia aranżacji pomieszczenia. Dla naszego codziennego użytkowania równie ważne będą też funkcjonalności tapicerki. Poznaj świat tkanin i wybierz tę, która spełni wszystkie Twoje oczekiwania.

Nowadays, upholstery fabrics have more than just a decorative function. The current fabrics are materials for special tasks... easy to clean, waterproof, stain-resistant, ecological, as well as beautiful and available in thousands of colours.

Velour, chenille, and woven fabrics are just some of the types currently available on the market. Each of them has a different structure, softness and external appearance; these are the features that are important from the point of view of room arrangement. The functionalities of fabrics will also be important for their everyday use. Discover the world of fabrics and choose the one that will meet all your expectations.





### Tkaniny o wyjątkowej miękkości

Jeśli jesteś miłośnikiem stylu glamour, lubisz odrobinę luksusu we wnętrzu, to pomyśl o welurze – tkaninie solidnej i wytrzymałej, aczkolwiek miękkiej. Materiał welurowy pięknie wygląda nie tylko na sofach czy narożnikach, ale również na krzesłach czy łóżkach sypialnianych. Welury z kolekcji **Nube** to nietuzinkowy wygląd połączony z dużą funkcjonalnością.



### Plecionki - tradycja i wytrzymałość

Najbardziej popularne tkaniny o wyraźnym splocie, niezwykle wytrzymałe i odporne na mechacenie, przez co zachowują swoje właściwości na lata. Eleganckie i zwarte, idealne na meble o prostej bryle. Przykładem ponadczasowej plecionki jest tkanina **Marte**.

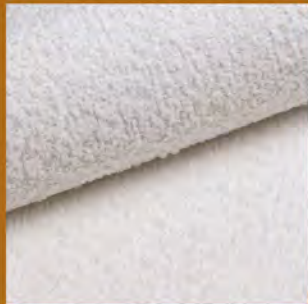

### Boucle nowy wymiar designu

Boucle to oryginalna tkanina z przędzy pętłkowej obecnie przeżywająca swój wielki renesans. Wykonana z materiałów recyklingowych (butelki pet) jest materiałem ekologicznym wspierającym dbałość o środowisko naturalne. Tkanina **Royal** to nasza odpowiedź na ponadczasową elegancję i ochronę środowiska.



### Tkaniny pet friendly

Jesteś miłośnikiem zwierząt? Masz w domu czworonoga? Materiały w technologii przyjaznej zwierzętom wykazują się podwyższoną odpornością na zaciągnięcia i zadrapania. Dodatkowo bardzo często tkaniny te mają właściwości hydrofobowe czy łatwoczyszczące. W palecie tkanin ELTAP **Savoi** jest dedykowana właścicielom zwierząt.

### Tkaniny łatwoczyszczące

Narożniki i sofy, które możemy w łatwy sposób wyczyścić to marzenie każdego rodzica. Tkaniny obiciowe proste w czyszczeniu można szybko odplamić za pomocą czystej ściereczki nasączonej wodą i odrobiną piany z mydła. Należy pamiętać, że tkaniny nie powinno się pocierać intensywnie, lecz delikatnie dociskając szmatkę, zetrzeć plamę. Tkaniny łatwoczyszczące nie wchłaniają wody.

### Exceptionally soft fabrics

If you are a fan of the glamour style and want a bit of luxury in the interior, think about velour – a reliable, durable, but soft fabric. Velour fabric looks beautiful not only on sofas and corner settees, but also on chairs or bedroom beds. Velour from the Nube collection provides an extraordinary look combined with great functionality.

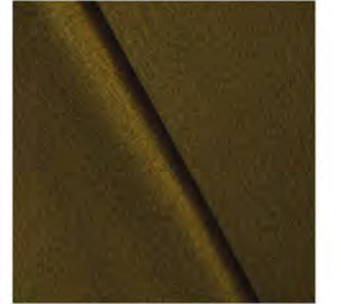

### Woven fabrics – tradition and durability

The most popular fabrics with a distinct weave, extremely durable and resistant to pilling, thanks to which they retain their properties for years. Elegant and tight, perfect for furniture with a simple shape. An example of a timeless woven fabric is Marte.



### Boucle a new dimension of design

Boucle is an original loop wale-yarn fabric currently coming back into style. It is an ecological fabric made of recycled materials (PET bottles), which supports caring for the natural environment. The Royal fabric is our answer to timeless elegance and environmental protection.



### Pet-friendly fabrics

Are you an animal lover? Do you have a pet at home? Pet-friendly fabrics have increased resistance to snags and scratches. In addition, these materials often have hydrophobic or easy-cleaning properties. Among the ELTAP fabrics, Savoi is dedicated precisely to animal owners.

### Easy-to-clean fabrics

Corner settees and sofas that can be easily cleaned are every parent's dream. Upholstery fabrics that are easy to clean with a cloth soaked in water with some soap foam added. You should keep in mind that the fabric should not be rubbed intensively; wipe stains by gently pressing the cloth. Easy-to-clean fabrics do not absorb water.





# Narożniki Corners

## Narożniki – wygodnie i funkcjonalnie

Narożniki to sprytne meble, które dzięki ergonomicznej konstrukcji dobrze wykorzystują przestrzeń w salonie. Ich atutem jest dostępność w wielu różnych kolorach, stylach, tkaninach i ustawieniach. Zachwycają zdobieniami w postaci pikowań, przeszyc albo modnych wzorów. Mogą być skonstruowane w kształcie liter U, L lub uniwersalne. Zapewniają miejsce do spotkań towarzyskich czy też rodzinnych maratonów filmowych. Kolejnym plusem naszych narożników z kolekcji ELTAP jest także opcja wyboru mebla z pojemnikiem na pościel i funkcją spania. Narożnik to idealny, wielofunkcyjny mebel, który posłuży do odpoczynku w dzień i snu w nocy.

## Corner settees – comfortable and functional

Corner settees are clever pieces of furniture that, thanks to their ergonomic design, make good use of the space available in a living room. Their advantage is being available in many different colours, styles, fabrics and types of arrangement. They delight with ornaments in the form of quilting, stitching or fashionable patterns. They can be U-shaped, L-shaped or universal. They provide a place for social meetings or family film marathons. An additional advantage of our corner settees from the ELTAP collection is the option of choosing a piece of furniture with a container for bedding and a sleeping function. A corner settee is an ideal multifunctional piece of furniture that may be used for resting during the day and sleeping at night.



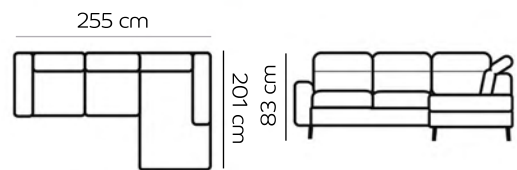
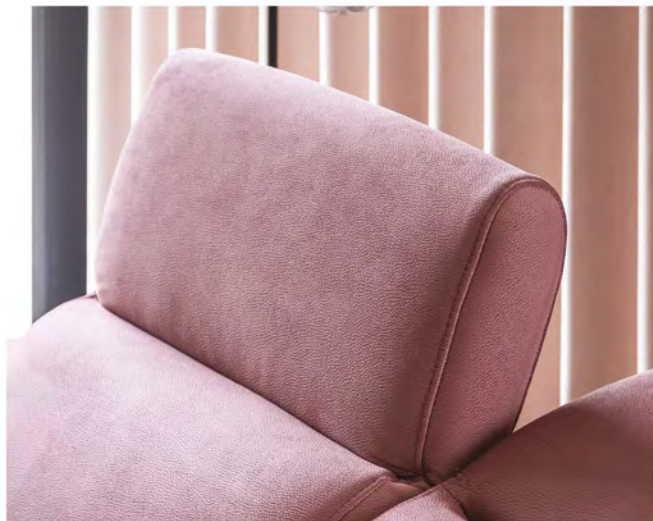

120 x 195 cm

# Noble





# Larde



powierzchnia  
spania  
sleeping  
surface

126 x 240 cm

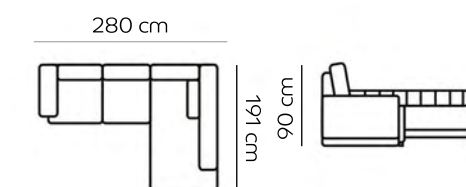





 powierzchnia  
 spania  
 sleeping  
 surface

125 x 210 cm

# Laurence





# Bretan



powierzchnia  
spania  
sleeping  
surface

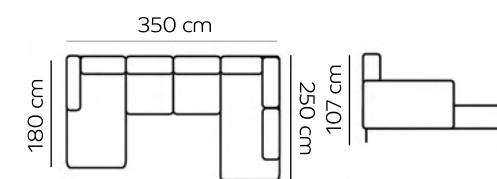



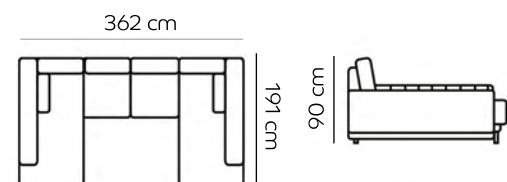

124 x 320 cm

# Larco





# Silva



powierzchnia  
spania  
sleeping  
surface

123 x 240 cm

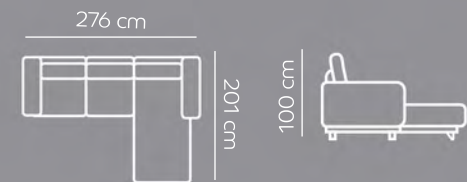



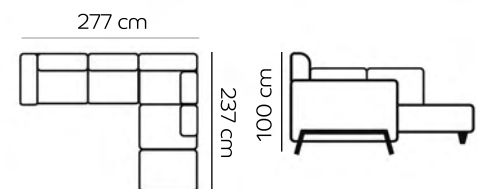

 powierzchnia spania  
sleeping surface

130 x 215 cm

# Cassara





# Bonito



powierzchnia  
spania  
sleeping  
surface

120 x 300 cm

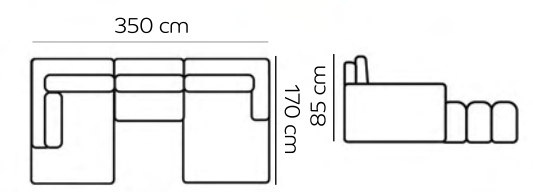



# Neviro



powierzchnia  
spania  
sleeping  
surface

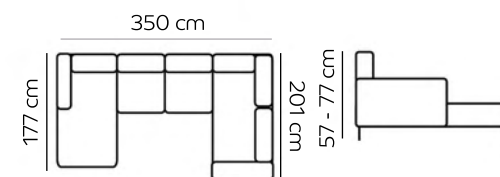



# Silla



powierzchnia  
spania  
sleeping  
surface

123 x 240 cm

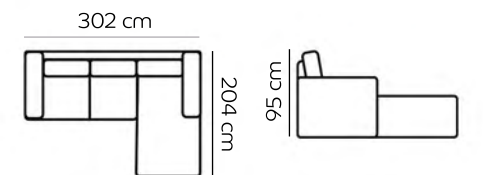



# Torrense



powierzchnia  
spania  
sleeping  
surface

140 x 215 cm

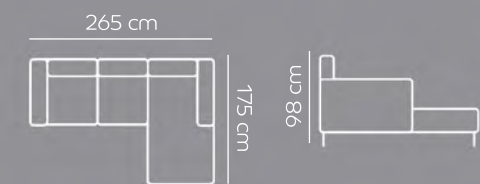



# Theodore



powierzchnia  
spania  
sleeping  
surface

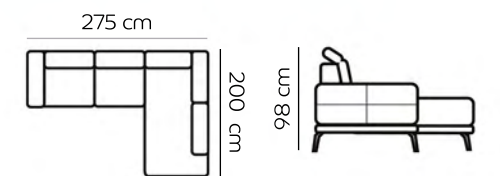



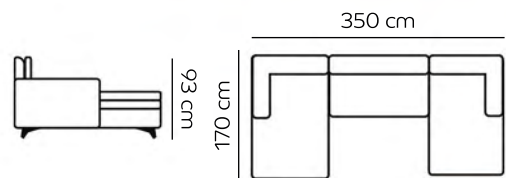

 powierzchnia spania  
sleeping surface

110 x 295 cm

# Vertizo





# Montez



powierzchnia  
spania  
sleeping  
surface

120 x 275 cm

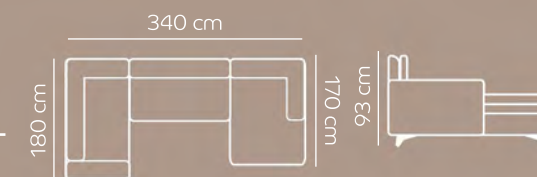



# Louis



powierzchnia  
spania  
sleeping  
surface

125 x 210 cm

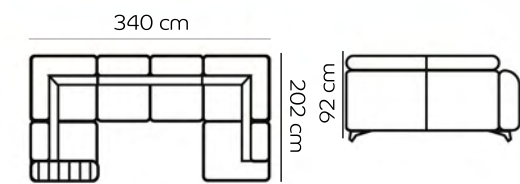



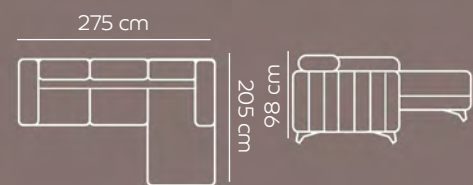

 powierzchnia spania  
sleeping surface

125 x 210 cm

# Grayson





# Lacante



powierzchnia  
spania  
sleeping  
surface

123 x 265 cm

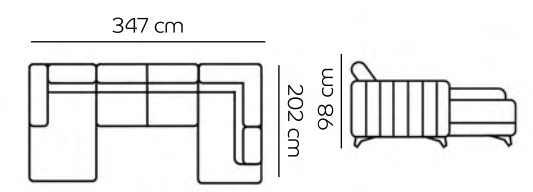



# Lanvin



powierzchnia  
spania  
sleeping  
surface

125 x 195 cm

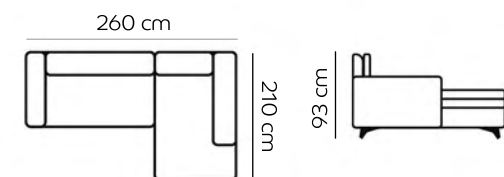



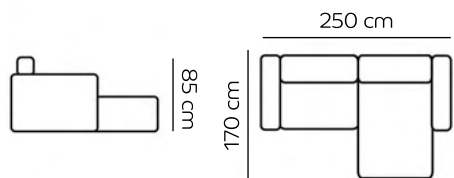

125 x 195 cm

# Bonett





# Anton

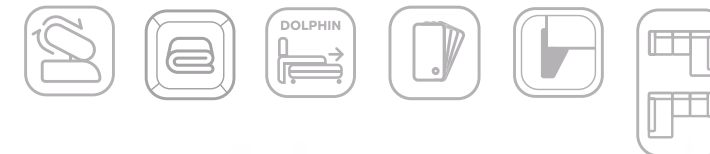

powierzchnia  
spania  
sleeping  
surface

125 x 193 cm

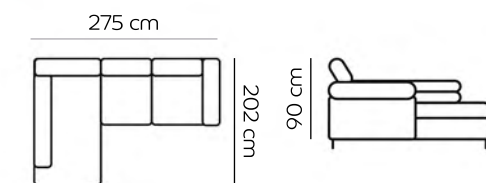



# Thiago



powierzchnia  
spania  
sleeping  
surface

125 x 265 cm

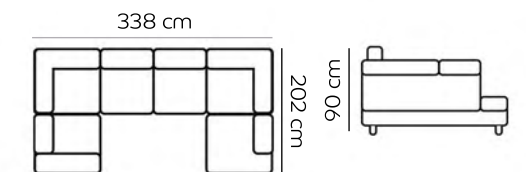



# Josette



powierzchnia spania  
sleeping surface

110 x 300 cm

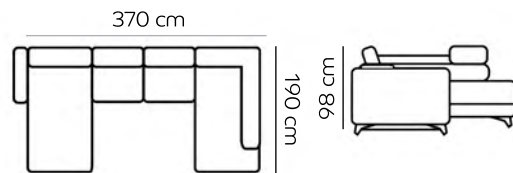

# Mariall



powierzchnia spania  
sleeping surface

110 x 240 cm

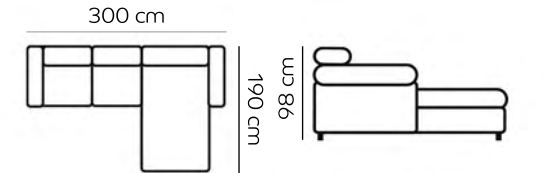



# Giovanni



powierzchnia spania  
sleeping surface

210 x 295 cm

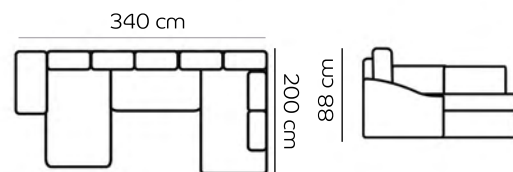

# Loreto



powierzchnia spania  
sleeping surface

125 x 190 cm

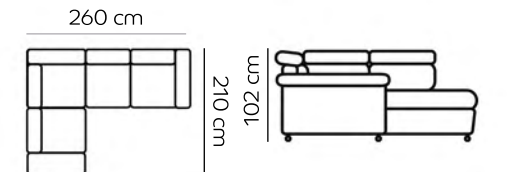



# Federico



powierzchnia spania  
sleeping surface

120 x 200 cm

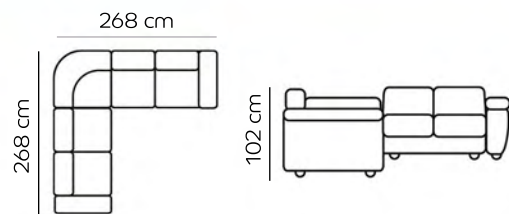

# Letto



powierzchnia spania  
sleeping surface

125 x 253 cm

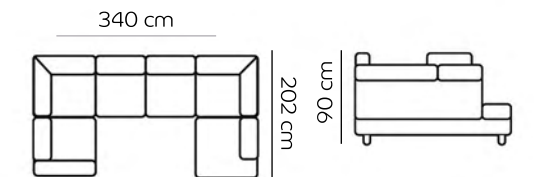



# Eduardo



# Eridano



powierzchnia spania  
sleeping surface

125 x 265 cm

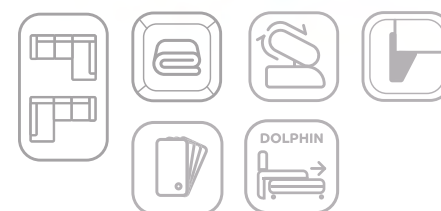
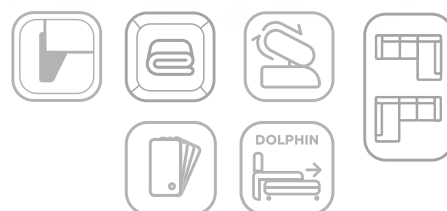
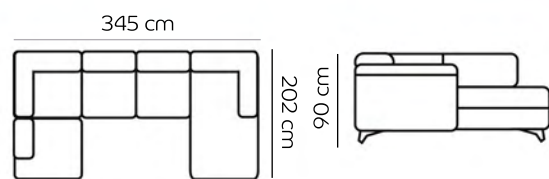

powierzchnia spania  
sleeping surface

125 x 193 cm

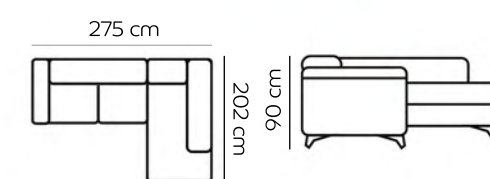



# Lorelle



# Roxi



powierzchnia spania  
sleeping surface

110 x 200 cm

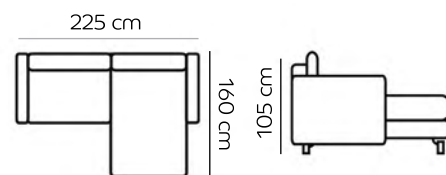

powierzchnia spania  
sleeping surface

125 x 215 cm

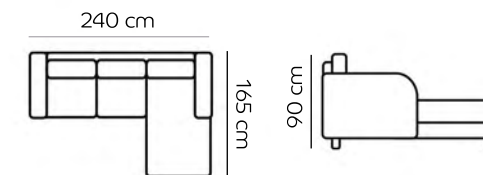



# Ricardo



# Rodrigo



powierzchnia spania  
sleeping surface

125 x 210 cm

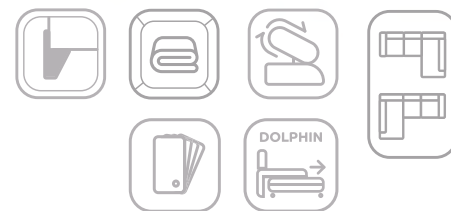
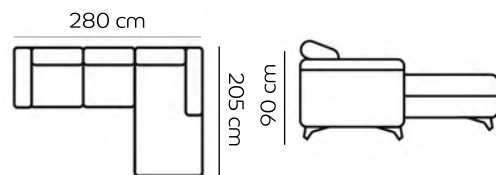

powierzchnia spania  
sleeping surface

125 x 266 cm

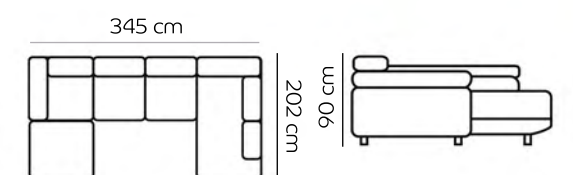



# Escada



powierzchnia spania  
sleeping surface

110 x 250 cm

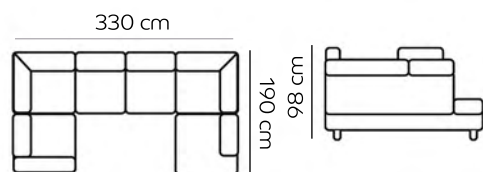

# Kairos

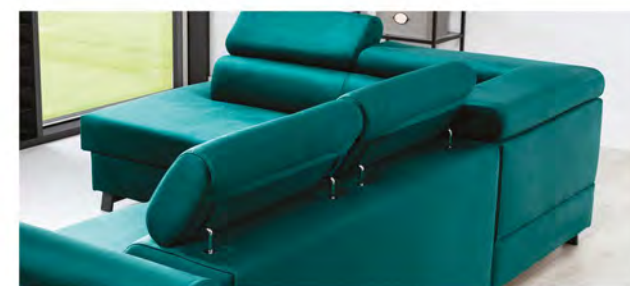

powierzchnia spania  
sleeping surface

125 x 190 cm

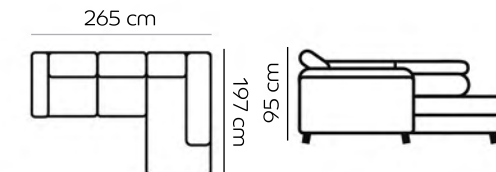



# Solange



# Sorento



powierzchnia  
spania  
sleeping  
surface

126 x 210 cm

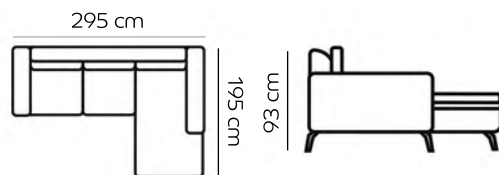

powierzchnia  
spania  
sleeping  
surface

126 x 210 cm

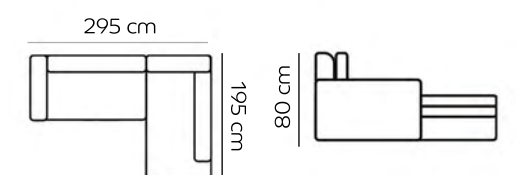



# Evanell



powierzchnia spania  
sleeping surface

125 x 265 cm

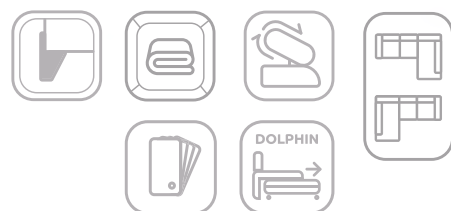
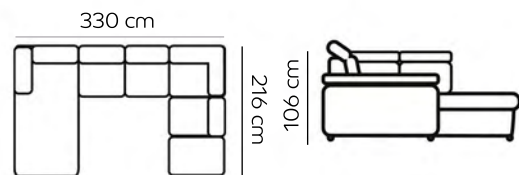

# Trevisco



powierzchnia spania  
sleeping surface

127 x 210 cm

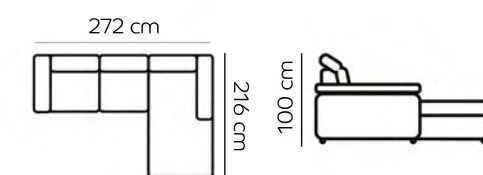



# Vento



powierzchnia spania  
sleeping surface

126 x 305 cm

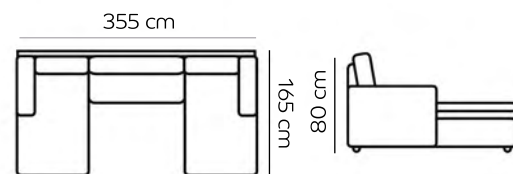

# Verso



powierzchnia spania  
sleeping surface

135 x 195 cm

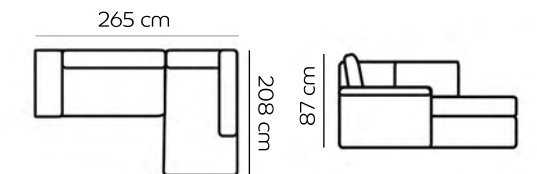



# Asgard L



powierzchnia spania  
sleeping surface

120 x 210 cm

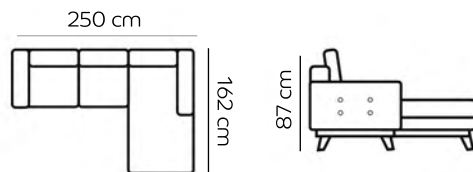

# Asgard U



powierzchnia spania  
sleeping surface

120 x 282 cm

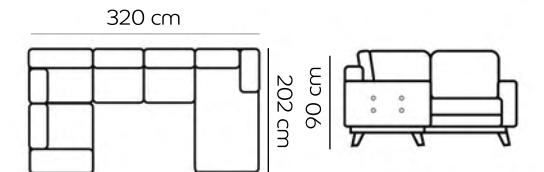



# Armando



powierzchnia  
spania  
sleeping  
surface

125 x 198 cm

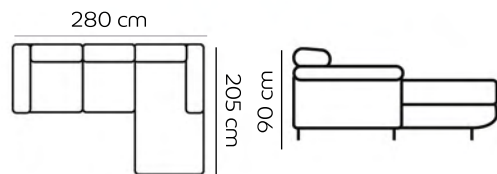

# Damario



powierzchnia  
spania  
sleeping  
surface

126 x 275 cm

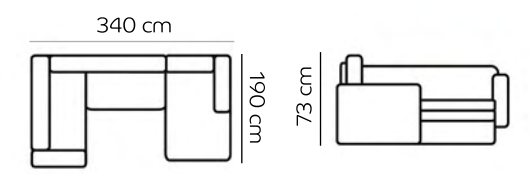



# beże i brązy

czyli największe trendy tego roku

## Wybierz jasne kolory narożnika

Minimalizm to silnie rozwijający się trend ostatnich lat. Pojawia się zarówno w życiu codziennym, jak i w modzie czy w dekoracji wnętrz. We wnętrzarstwie styl minimalistyczny, zwany też stylem japandi, to połączenie skandynawskiego designu z wabi-sabi trendem ze szkoły japońskiej. Ze stylu skandynawskiego zaczerpnięta została prostota, stosowanie naturalnych materiałów, stonowana kolorystyka i ład. Ze stylu wabi-sabi zapożyczono akcentowanie przestrzeni, dbanie o dobre doświetlenie pomieszczeń naturalnym światłem, ograniczanie dodatków do niezbędnego minimum oraz przywracanie pierwotnej funkcjonalności uszkodzonym przedmiotom (recykling). Główną rolę odgrywają tu czyste linie, które nie zakłócają przestrzeni. Sofa w prostym, eleganckim kształcie będzie modna przez lata a narożnik o prostej, eleganckiej linii idealnie wpisze się we wnętrze zarówno klasyczne, jak i nowoczesne. Wybierz subtelne kolory bez wzorów, aby podkreślić prostotę umeblowania. Preferowane są jasne kolory, delikatne odcienie bieli, kremu lub brązu, dlatego przestrzeń wydaje się większa i bardziej przestronna.

## Funkcjonalny design kanapy

Nowoczesny design współgra również z funkcjonalnością. Sofy i narożniki to nie tylko czyste linie, ale również posiadanie wielu funkcjonalności. Odpowiednio dobrane i połączone elementy tworzą harmonijną całość i emanują spokojem oraz wyciszeniem. Dodatkowy pojemnik w narożnikach pozwoli schować zapasowe koce czy poduszki lub po prostu rzeczy, których używamy okazjonalnie, co wpływa na uporządkowanie otaczającej nas przestrzeni. Najważniejsze jest przemyślenie ilości kupowanych mebli, których potrzebujesz. Możesz nadać swojemu wnętrzu indywidualny charakter dzięki oryginalnym elementom, takim jak designerskie łóżko, sofa czy stolik.

## Dodatki z naturalnych materiałów

Minimalizm ma wiele zalet. Jego prostota daje wiele możliwości dekoracyjnych, podkreślających funkcjonalność i ponadczasowość. Doskonałym uzupełnieniem stonowanych, jasnych wnętrz są elementy drewniane czy kamienne. Stolik do kawy z drewnianym blatem czy dębowe półki dodadzą elegancji i ciepła do mieszkania. Takie meble nie zdominują ogólnego wyglądu, bo są ponadczasowe i naturalne. Małe, proste w formie elementy dekoracyjne, kamienne tace czy białe wazon z trawą pampasową to charakterystyczne elementy stylu japandi. Spokój i odpoczynek w jasnych przestrzeniach, w których nie mamy zbędnych mebli czy innych, niepotrzebnych przedmiotów, jest niebywale komfortowy. Ukojenie płynące z naturalnych materiałów i delikatnych barw jest nie bez znaczenia w dzisiejszym zabieganym świecie. Przestronne, lecz minimalistyczne wnętrza, a do tego wysoki komfort narożnika czy sofy sprawi, że zechcesz mieszkać w stylu japandi.

# beiges and browns

the biggest trends of this year

## Choose bright colours for a corner settee

Minimalism is a quickly-developing trend in recent years. Both in everyday life, as well as in fashion and interior decoration. In interior design, the minimalist style, also known as the japandi style, is a combination of Scandinavian design with the Japanese wabi-sabi trend. Taken from the Scandinavian style are: simplicity, the use of natural materials, subdued colours and order. And from the wabi-sabi style: putting emphasis on the space, taking care of good access to natural light in rooms, limiting the accessories to the necessary minimum, and restoring the original functionality of damaged items (recycling). Clear lines that do not disturb the space play a major role here. A sofa in a simple, elegant shape will stay fashionable for years and a corner settee with a simple elegant line will perfectly fit into both classic and modern interiors. Choose subtle colours without patterns to emphasise the simplicity of the furnishings. Light colours, soft shades of white, cream or brown are preferable, so the space seems larger and more spacious.

## Functional couch design

Modern design also goes hand in hand with functionality. Sofas and corner settees are not only about having clean lines, but also many functionalities. Properly selected and combined parts create a harmonious whole and provide the feel of peace and tranquillity. The additional container in the corner settees will allow you to store spare blankets or pillows, or simple the things that you use occasionally, which helps to unclutter the space around you. The most important thing to consider is the number of the pieces furniture you need to buy. You may give your interior an individual character thanks to original elements, such as a designer bed, sofa or table.

## Accessories made of natural materials

Minimalism has many advantages. Its simplicity provides many options for decoration, which emphasise functionality and timelessness. Wooden or stone elements perfectly complement subdued, bright interiors. A coffee table with a wooden top or shelves will add elegance and warmth to your home. Such furniture does not overwhelm the overall look, it is timeless and natural. Small, simple decorative elements, stone trays or white vases with pampas grass are characteristic elements of the japandi style. The feeling of peace and relaxation in bright spaces where we do not have any unnecessary furniture or knick-knacks is extremely comfortable. The calmness coming from natural materials and delicate colours is important in today's busy world. All of this together with the comfort of a corner settee or sofa will make you want to live in the japandi style.



# Sofy Sofas

## Sofy i kanapy - sposób na komfort

Tapicerowane sofy, kanapy czy wersalki to klucz do komfortu. Dzięki supermiękkim materiałom w ciekawych odcieniach kanapy od ELTAP zapewniają miejsce, w którym można błogo odpoczywać, jednocześnie dodając stylowy akcent do domowego wnętrza. Ponadto nasze meble są dostępne w różnych kształtach i rozmiarach. Z tego właśnie powodu dopasowanie kanapy czy sofy do panującego wystroju jest niezwykle łatwe. Ukryte właściwości kanap w postaci pojemników na pościel czy rozkładanej funkcji spania są jednym z wielu atutów tego typu mebli. Nie sposób przejść obojętnie obok zjawiskowych mebli wypoczynkowych ELTAP.

## Sofas and Couches – a way to find comfort

Upholstered sofas, couches and convertibles are the key to comfort. Thanks to super-soft materials in interesting shades, ELTAP sofas provide a place where you can relax blissfully, at the same time adding a stylish accent to your home interior. In addition, our furniture is available in a variety of shapes and sizes. This is why matching the couches or sofas to your current decor is extremely easy. The hidden properties of couches in the form of bedding containers or a fold-out sleeping functions are one of the many advantages of this type of furniture. It is impossible to ignore the phenomenal ELTAP leisure furniture.



# Aros 2F



powierzchnia spania  
sleeping surface

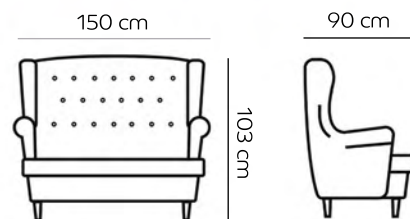

# Asgard 3F



powierzchnia spania  
sleeping surface

133 x 196 cm

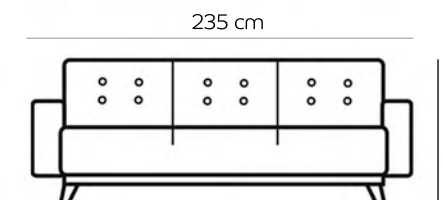

95 cm





# Dalia



# Elise



powierzchnia  
spania  
sleeping  
surface

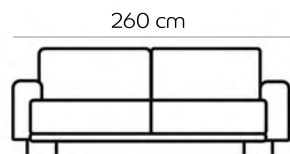

260 cm

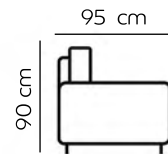

90 cm

95 cm



powierzchnia  
spania  
sleeping  
surface

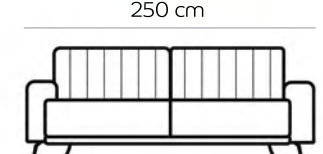

250 cm

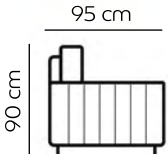

90 cm

95 cm

145 x 215 cm

145 x 215 cm



# Revi



powierzchnia spania  
sleeping surface

140 x 200 cm

215 cm



98 cm

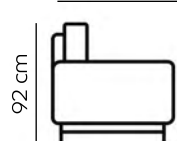

92 cm



# Silla



powierzchnia spania  
sleeping surface

145 x 200 cm

260 cm

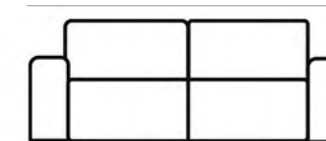

104 cm

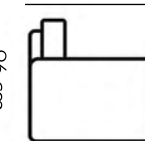

96 cm



# Silva



# Torrense



powierzchnia spania  
sleeping surface

145 x 200 cm

236 cm

95 cm

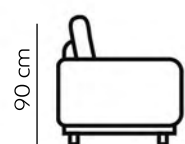
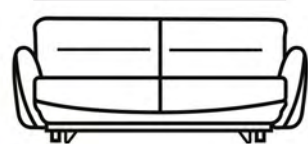

powierzchnia spania  
sleeping surface

195 cm

103 cm

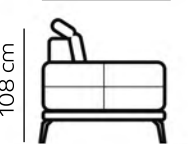
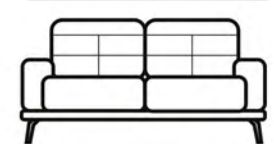

108 cm



# Lazaro



# Megis



powierzchnia  
spania  
sleeping  
surface

125 x 195 cm

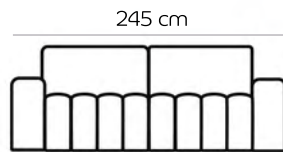

245 cm

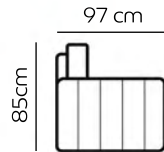

85cm

97 cm



powierzchnia  
spania  
sleeping  
surface

145 x 200 cm

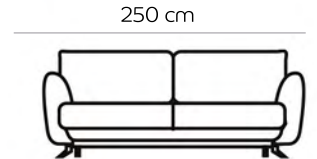

250 cm

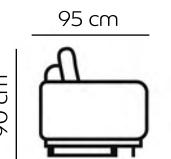

90 cm

95 cm



# Bellis



powierzchnia spania  
sleeping surface

110 x 190 cm

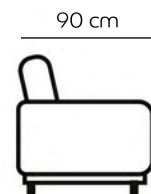
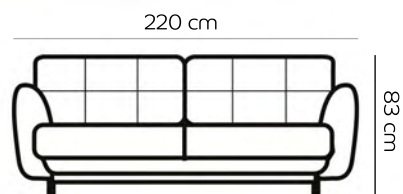

# Selene



powierzchnia spania  
sleeping surface

110 x 195 cm

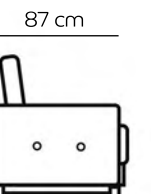
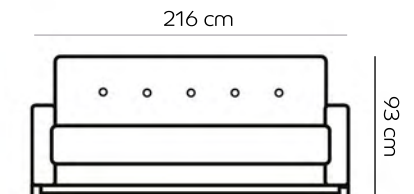



# Laurence



powierzchnia spania  
sleeping surface

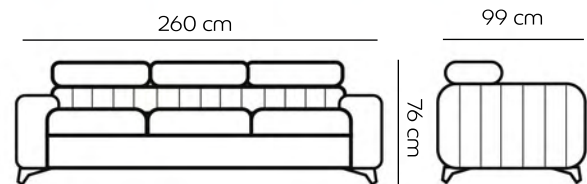

136 x 199 cm



### Fotele, szezlongi i pufy - dodatki idealne

Fotele, pufy i szezlongi pełnią ważną funkcję w wielu domach. Oprócz tego, że zapewniają bardzo potrzebne miejsca do siedzenia w salonie czy sypialni, mogą również dodać wdzięku, piękna, stylu i elegancji każdemu pomieszczeniu, w jakim się znajdują. To dodatki meblowe o wszechstronnym charakterze, łączące funkcjonalność i estetykę, a także fascynujące meble - synonim komfortu i relaksu. Każdy z nich może być częścią kompletu wypoczynkowego lub meblem wolnostojącym. Idealnie sprawdzają się w otwartych przestrzeniach dziennych i nowoczesnych salonach. W ELTAP oferujemy szeroki wybór puf, foteli i szezlongów, które staną się idealnym dodatkiem do wielu wnętrz.

### Armchairs, Chaise longues and Pouffes – the perfect accessories

Armchairs, pouffes and chaise longues play an important role at many homes. In addition to providing much-needed seating in a living room or bedroom, they can also add grace, beauty, style and elegance to any room they are put in. These are furniture accessories with a versatile character, combining functionality and aesthetics, as well as fascinating pieces of furniture – they are synonymous with comfort and relaxation. Each one of them can be used as a part of a leisure set or a free-standing piece of furniture. They are perfect for open living spaces and modern living rooms. At ELTAP, we offer a broad selection of pouffes, armchairs and chaise lounges, which may become a perfect addition to many interiors.

# Fotele, szezlongi i pufy Armchairs, chaise longues and pouffes



# Aros 1F

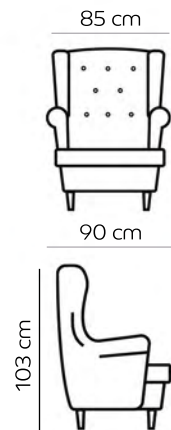

# Asgard 1F

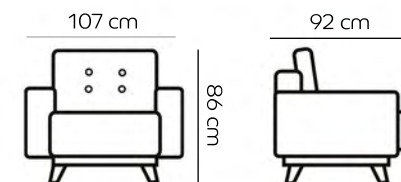

# Arti 1F

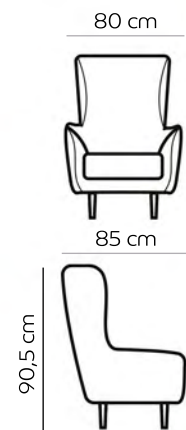



# Lazaro

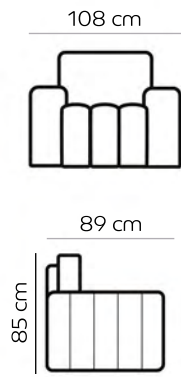

# Megis

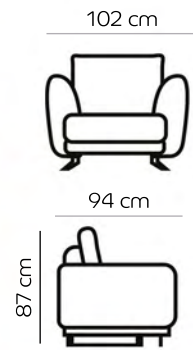

# Dalia

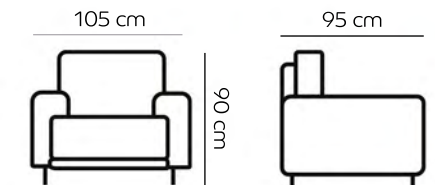



# Silva

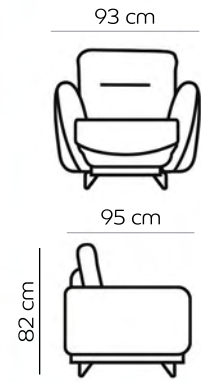

# Torrense



# Vivien





# Doro

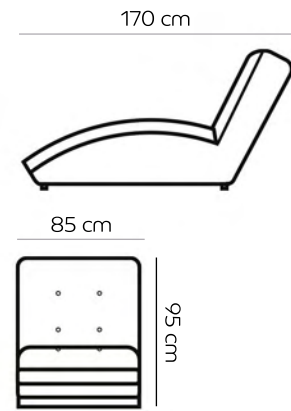

# Loren



# Taco

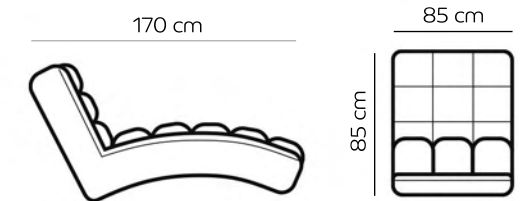
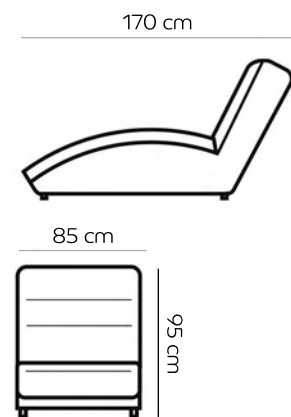



# Asgard

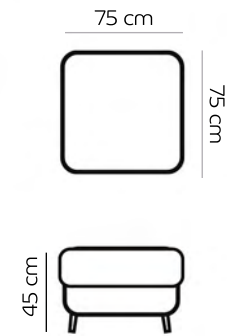

# Kelim

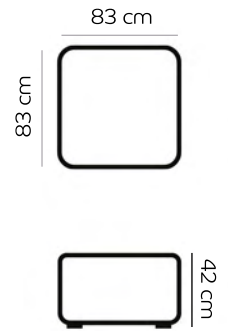

# Bero

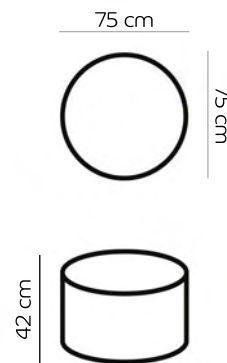

# Lara

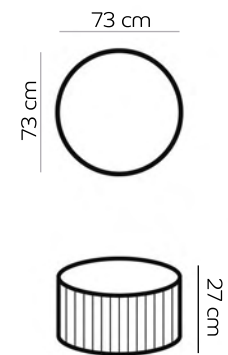



# Lazaro

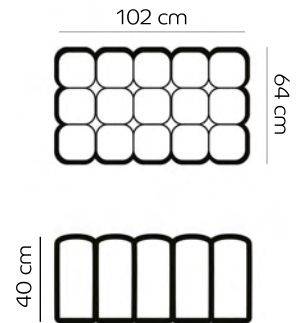

# Lorelle

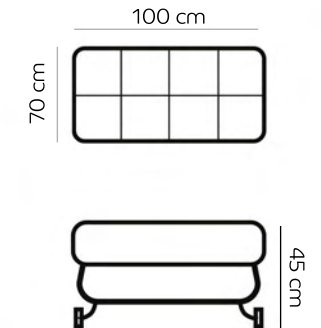

# Linsy

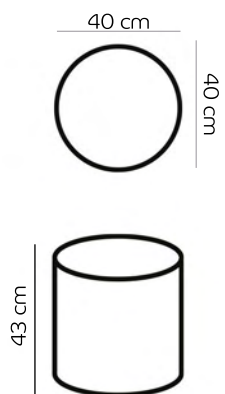

# Monty

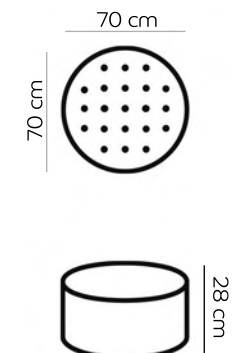



# Megis

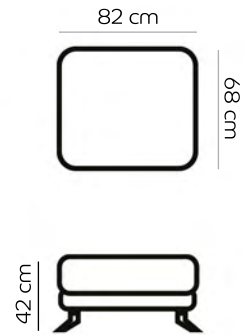

# Selene

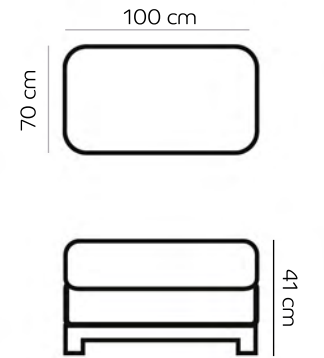

# Nolla

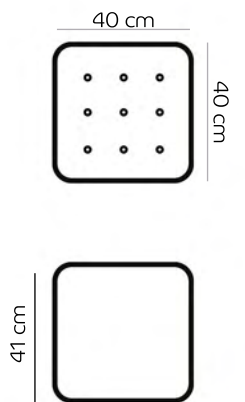

# Silla

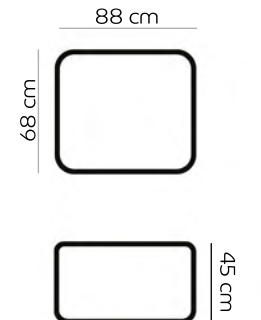



# Silva

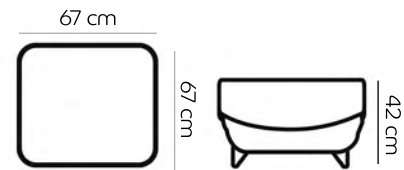

# Sofia

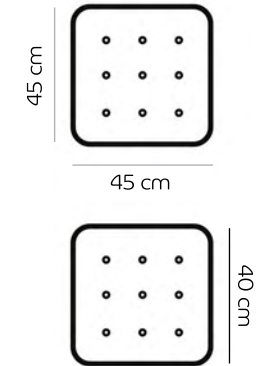

# Torrense

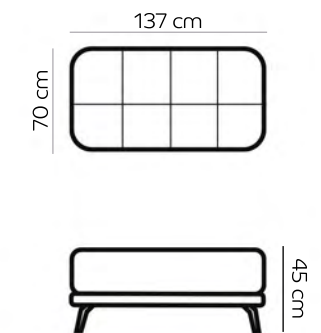



# inspiracje kolorystyczne

## color inspirations

W ELTAP oferujemy różnorodne domowe akcenty, aby nadać Twojemu wnętrzu idealnego stylu, blasku lub odrobiny elegancji. Wystrój domu może wywierać duży wpływ na otoczenie przy minimalnym wysiłku. Wystarczy duże lustro w przedpokoju lub oryginalny stolik czy komoda w salonie. Drobne zmiany mogą tchnąć nowe życie w Twój dom. ELTAP prezentuje szeroką ofertę mebli i dodatków, które pomogą zaaranżować wymarzone wnętrza.

At ELTAP, we offer a variety of home accents to give your interior the perfect style, some sparkle, or a touch of elegance. Home decor can make a big impact on your surroundings with minimal effort. All you need is a large mirror in the hall or an original table or chest of drawers in the living room. Small changes can breathe new life into your home. ELTAP presents a wide range of furniture and accessories that will help you arrange your dream interiors.



### LUSTRA – subtelna zmiana otoczenia

Lustra to subtelny i stylowy dodatek do każdego domu. Umieszczając lustro w odpowiedniej części pomieszczenia, będziesz w stanie zoptymalizować naturalne światło i sprawić, że Twoja przestrzeń będzie wyglądać na większą i jaśniejszą. Wybierz duże lustro i ustaw je obok lub naprzeciwko okna, aby „wyłapać” naturalne światło. Nasza oferta luster z łatwością radzi sobie z rozjaśnianiem ciemniejszych części domu.

### STOLIKI KAWOWE – czas na chwilę odpoczynku

Piloty, czasopisma, książki i filiżanki z kawą – stoliki ustawione w salonie mają często wiele do udźwignięcia. Dlatego warto wybrać ciekawy i funkcjonalny stolik kawowy. Może być elegancki i minimalistyczny lub bardziej zorganizowany dzięki ukrytemu schowkowi.

### MIRRORS – a subtle change in surroundings

Mirrors are a subtle and stylish addition to any home. By putting a mirror in the right part of a room, you will be able to optimise the natural light and make your space appear larger and brighter. Choose a large mirror and put it next to or in front of a window to “catch” more natural light. Our range of mirrors can easily brighten the darker parts of your home.

### COFFEE TABLES – time for some rest

Remote controls, magazines, books and coffee cups – the tables standing in living rooms often have a lot to handle. Therefore, it is a good idea to choose an interesting and functional coffee table. It may be elegant and minimalistic, or more organised thanks to a hidden storage space.



# zadbaj o każdy detal

## take care of every detail

### Meble do każdego pomieszczenia

Systemy mebli od ELTAP zostały zaprojektowane tak, aby pomóc Ci utrzymać porządek w całym domu. Każdy komplet naszych mebli składa się z części, takich jak półki, komody, szafy i szafki, które można zestawiać w niepowtarzalne kombinacje dopasowane do Twojej przestrzeni, a także potrzeb.

### Rozważ przechowywanie

Rozważając miejsce do przechowywania, warto zacząć od konsol i szafek RTV. Zapewniają one stylową platformę dla Twojego telewizora. Jeśli wolisz ukryć odtwarzacze DVD i inne domowe multimedia, wybierz meble z dużą ilością szuflad, półek i szafek. Wystaw książki, zdjęcia w ramach i inne drobiazgi na szafkach, regałach i półkach w salonie. Zaoszczędź miejsce i uporządkuj przestrzeń dzięki schowkom.

### Skup się na kolorach

Odcienie dębu idealnie komponują się z klasycznymi elementami wystroju wnętrza. Nasze kolekcje Lanzzi i Avorio są dostępne w opcji kolorystycznej, jaką jest połączenie bieli lub czerni z dębem artisan. Dlatego z pewnością odnajdą się w wielu ciekawych aranżacjach.

### Consider storage

When considering storage space, start with consoles and TV cabinets. They provide a stylish platform for your TV. If you prefer to hide DVD players and other home media, choose furniture with lots of drawers, shelves and cabinets. Display books, framed photos and other knick-knacks on cabinets, bookcases and shelves in your living room. Save space and organise it thanks to storage compartments.

### Furniture for every room

The ELTAP furniture systems have been designed to help you keep the whole house in order. All our furniture systems consist of parts such as shelves, chests of drawers, wardrobes and cabinets, which can be put together in unique combinations tailored to your space and needs.

### Focus on colours

Shades of oak blend in perfectly with classic interior design elements. Our Lanzzi and Avorio collections are available in a combination of white or black colour with artisan oak. Therefore, they will surely fit many interesting arrangements.

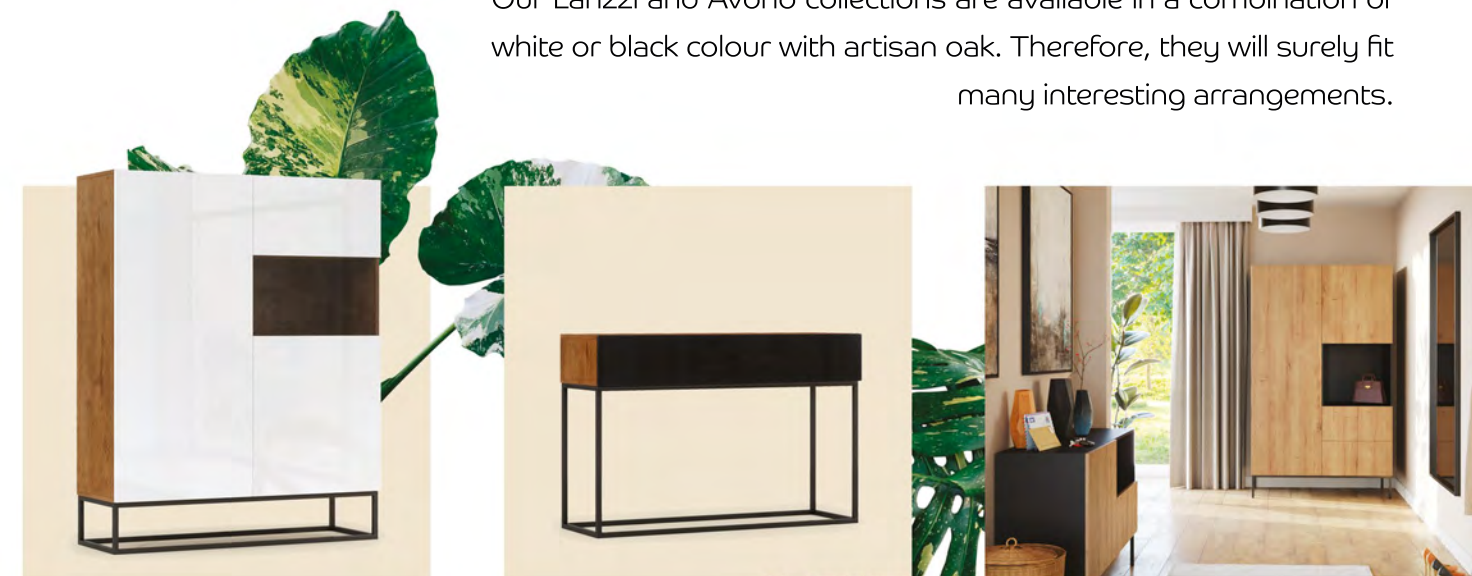



# Cloue

65/75 cm

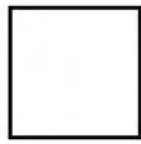

65/75 cm

35/41 cm

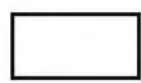

# Merala

65 cm

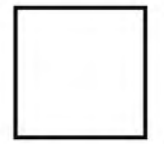

65 cm

35 cm

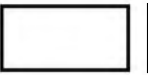

# Linze

75 cm

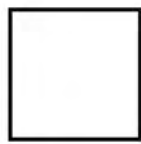

75 cm

45 cm

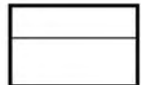

# Verto

100 cm



60 cm

45 cm

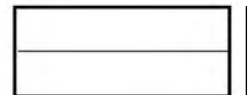



# Clar

65/75 cm

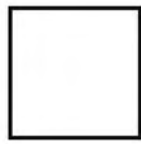

65/75 cm

36/42 cm

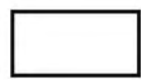

# Gavino

90 cm

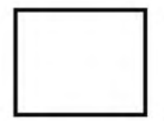

60 cm

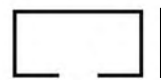

42 cm



# Fresco

90 cm



60 cm

42 cm

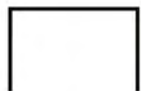

# Lupe

75 cm

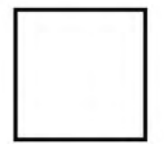

75 cm

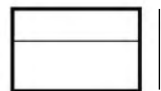

46 cm





# Moss

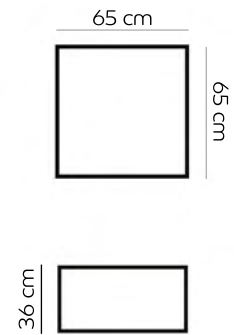

# Nevio

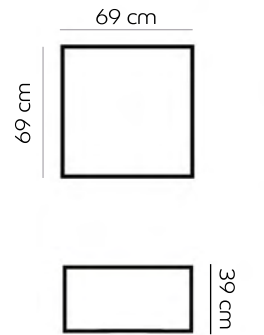

# Marlo

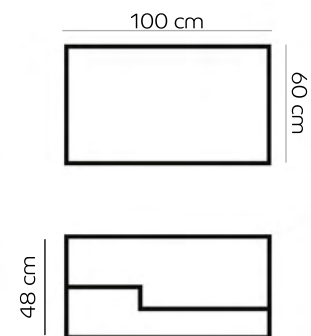

# Torvi

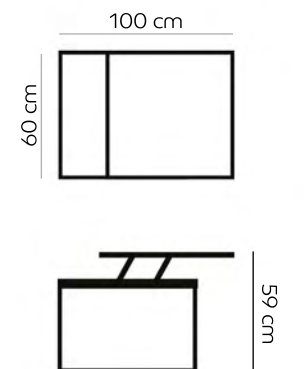



# Vigo

45 cm

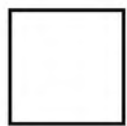

45 cm

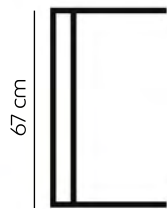

67 cm



# Vince

100 cm

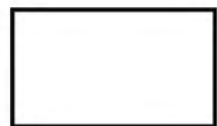

60 cm

46 cm

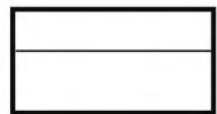



# Arizona

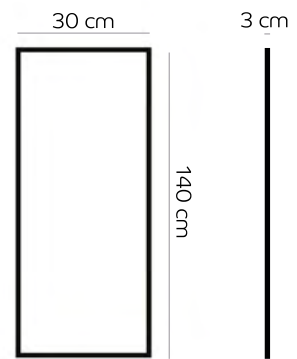

# Verona

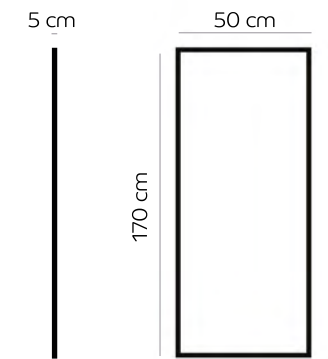



# Aruba

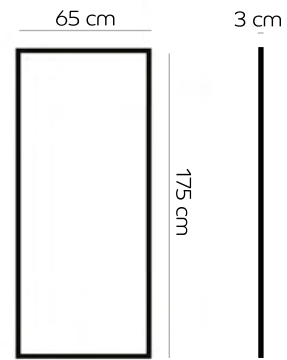

# Vasto

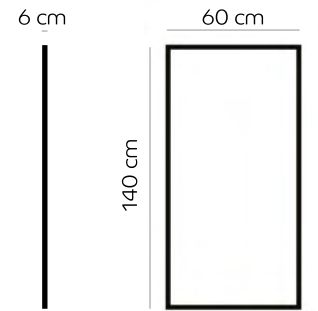

# Medina

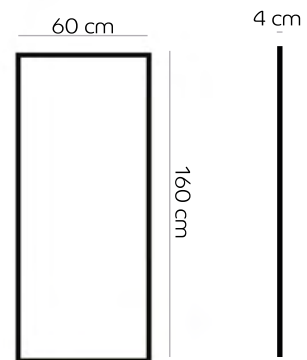



# Lanzzzi







Lanzzzi





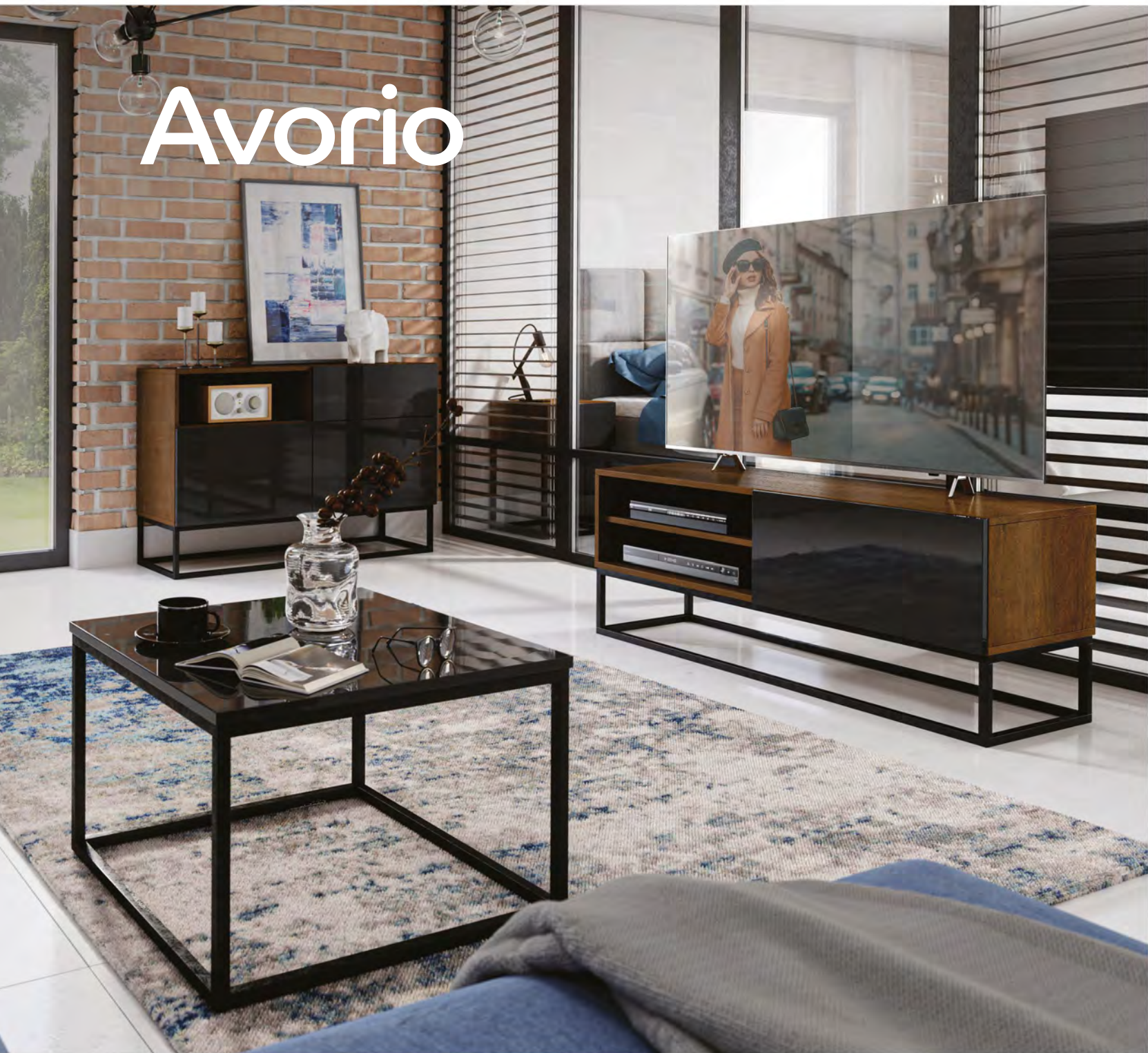

















# Avorio































model	wymiar (szer./wys./gł.) pow.spania (cm)	wyposażenie (wypełnienie)		typ mechanizmu rozkładania	pojemnik na pościel	typ montażu	regulowany zagiłówek	przesuwne oparcie	materiał, z którego wykonane są nóżki	model	wymiar	materiał	Pianka	delfin	liczba	L / P L / R	tak / yes	nie / no	
		siedzisko	oparcie																
model	dimensions (W/H/D) sleeping area (cm)	equipment (filling)		folding mechanism type	bedding container	mounting type	adjustable headrest	sliding backrest	material from which the legs are made	model	dimensions	material	Pianka	delfin	liczba	L / P L / R	tak / yes	nie / no	
		seat	backrest																
<b>Anton</b>	275/90/202 125/193	Pianka Foam T3040	Pianka Foam T2542	delfin dolfin	1	L / P L / R	tak / yes	nie / no		<b>Evanell</b>	330/106/216 125/265	Pianka Foam T3030	Pianka Foam T2542	delfin dolfin	1	L / P L / R	tak / yes	nie / no	
<b>Asgard L</b>	250/87/162 210/120	Pianka Foam T3030	Pianka Foam T2140	DL	1	universal	nie / no	nie / no		<b>Federico</b>	268/102/268 120/200	Pianka Foam T3040	Pianka Foam T2542	delfin dolfin	1	universal	tak / yes	nie / no	
<b>Asgard U</b>	320/90/202 282/120	Pianka Foam T3030	T2540	DL	1	universal	nie / no	nie / no		<b>Giovanni</b>	340/88/200 295/120	Pianka Foam T3040	Pianka Foam T2542	DL	1	L / P L / R	nie / no	nie / no	
<b>Armando</b>	280/90/205 125/198	Pianka Foam T3030	Pianka Foam T2542	delfin dolfin	1	L / P L / R	tak / yes	nie / no		<b>Grayson</b>	275/98/205 125/210	Pianka Foam T30 + HR	Pianka Foam T25	delfin dolfin	1	L / P L / R	tak / yes	nie / no	
<b>Bonett</b>	250/85/170 195/125	Pianka Foam HR + T2540	Pianka Foam HR + T2540	DL	1	L / P L / R	nie / no	nie / no		<b>Josette</b>	370/98/190 110/300	Pianka Foam T30 + HR	Pianka Foam T25	delfin dolfin	2	L / P L / R	tak / yes	nie / no	
<b>Bonito</b>	350/170/85 300/120	Pianka Foam HR + T2540	Pianka Foam HR + T2540	DL	1	L / P L / R	nie / no	nie / no		<b>Kairos</b>	265/95/197 125/190	Pianka Foam T3030 + HR	Pianka Foam T2542	delfin dolfin	1	L / P L / R	tak / yes	nie / no	
<b>Bretan</b>	350/107/180	Pianka Foam HR	Pianka Foam T21 + T25	-	0	L / P L / R	tak / yes	tak / yes		<b>Lacante</b>	347/98/202 265/123	Pianka Foam T3030 + HR	Pianka Foam T25	delfin dolfin	1	L / P L / R	tak / yes	nie / no	
<b>Cassara</b>	277/100/237 215/130	Pianka HR Foam 3035	Pianka Foam T2315	DL	1	L / P L / R	tak / yes	tak / yes		<b>Lanvin</b>	260/93/210 195/125	Pianka Foam T3040	Pianka Foam T2542	delfin dolfin	0	L / P L / R	nie / no	nie / no	
<b>Damaro</b>	340/73/190 275/126	Pianka Foam T3040	Pianka Foam T2542	delfin dolfin	0	L / P L / R	nie / no	nie / no		<b>Larco</b>	362/90/191 320/124	Pianka Foam HR 3035	Pianka Foam T2540	DL	1	universal	nie / no	nie / no	
<b>Eduardo</b>	345/90/202 125/265	High Qual- ity HR + T3030	Pianka Foam T2542	delfin dolfin	1	L / P L / R	tak / yes	nie / no		<b>Larde</b>	280/90/191 126/240	Pianka Foam HR	Pianka typu frytka fries type foam	DL	1	L / P L / R	nie / no	nie / no	















<b>Laurence</b>	275/98/205 125/210	Pianka Foam T30 + HR	Pianka Foam T25	delfin dolphin	1	L / P L / R	tak / yes	nie / no		<b>Silla</b>	302/95/204 240/123	Pianka Foam HR	Pianka Foam T25	DL	1	L / P L / R	nie / no	nie / no	
<b>Letto</b>	340/90/202 125/253	Pianka Foam T3040	Pianka Foam T2542	delfin dolphin	1	L / P L / R	tak / yes	nie / no		<b>Silva</b>	276/100/201 240/123	Pianka Foam HR 3035	Granulat piankowy Foam granules	DL	1	L / P L / R	nie / no	nie / no	
<b>Louis</b>	340/92/202 210/125	Pianka Foam T30 + HR	Pianka Foam T25	delfin dolphin	1	L / P L / R	tak / yes	nie / no		<b>Solange</b>	295/93/195 210/126	Pianka Foam T3040	Pianka Foam T2542	delfin dolphin	0	L / P L / R	nie / no	nie / no	
<b>Lorelle</b>	225/105/160 200/110	Pianka Foam HR	Pianka Foam T25	delfin dolphin	1	L / P L / R	tak / yes	nie / no		<b>Sorento</b>	295/80/195 210/126	Pianka Foam T3040	Pianka Foam T2542	delfin dolphin	0	universal	nie / no	nie / no	
<b>Loreto</b>	260/102/210 125/190	Pianka Foam T3030	Pianka Foam T2542	delfin dolphin	1	L / P L / R	tak / yes	nie / no		<b>Theodore</b>	275/98/200	Pianka Foam HR	Pianka Foam T21/T25	-	0	L / P L / R	tak / yes	tak / yes	
<b>Mariall</b>	300/98/190 110/240	Pianka Foam T30 + HR	Pianka Foam T25	delfin dolphin	1	L / P L / R	tak / yes	nie / no		<b>Thiago</b>	338/90/202 125/265	Pianka Foam High Quality HR + T3030	Pianka Foam T2542	delfin dolphin	1	L / P L / R	tak / yes	nie / no	
<b>Montez</b>	340/93/180 275/120	Pianka Foam T3040	Pianka Foam T2542	delfin dolphin	0	L / P L / R	nie / no	nie / no		<b>Torrense</b>	265/98/175 215/140	Pianka Foam HR	Pianka Foam T21/ T25	-	0	L / P L / R	tak / yes	tak / yes	
<b>Neviro</b>	350/77/69	Pianka Foam HR	Pianka Foam T21/T25	-	0	L / P L / R	tak / yes	tak / yes		<b>Trevisco</b>	272/100/216 127/210	Pianka Foam T3030	Pianka Foam T2542	delfin dolphin	1	L / P L / R	tak / yes	nie / no	
<b>Noble</b>	255/210/83 120x195	Pianka Foam HR	Pianka Foam T21	delfin dolphin	1	L / P L / R	tak / yes	nie / no		<b>Vento</b>	355/80/165 305/126	Pianka Foam T3040	Pianka Foam T2542	delfin dolphin	0	L / P L / R	nie / no	nie / no	
<b>Roxi</b>	240/90/165 215/125	Pianka Foam T3030/ HR3035	Pianka Foam T2540	delfin dolphin	1	universal	nie / no	nie / no		<b>Verso</b>	265/87/208 195/135	Pianka Foam T3040	Pianka Foam T2542	delfin dolphin	1	L / P L / R	nie / no	nie / no	
<b>Ricardo</b>	280/90/205 125/210	Pianka Foam High Quality HR + T3030	Pianka Foam T2542	delfin dolphin	1	L / P L / R	tak / yes	nie / no		<b>Vertizo</b>	350/93/170 295/110	Pianka Foam T3040	Pianka Foam T2542	delfin dolphin	0	universal	nie / no	nie / no	
<b>Rodrigo</b>	345/90/202 125/266	Pianka Foam T3040	Pianka Foam T2542	delfin dolphin	1	L / P L / R	tak / yes	nie / no											



## sofy, kanapy i wersalki | sofas, couches and sofa beds







model	wymiar (szer./wys./gl.) pow. spania (cm)	wyposażenie (wypełnienie)		typ mechanizmu rozkładania	pojemnik na pościel	typ montażu	regulowany zagiłówek	przesuwne oparcie	materiał, z którego wykonane są nóżki
		siedzisko	oparcie						
model	dimensions (W/H/D) sleeping area (cm)	equipment (filling)		folding mechanism type	bedding container	mounting type	adjustable headrest	sliding backrest	material from which the legs are made
		seat	backrest						

<b>Aros 2F</b>	150/90/103	T3030	T2542	-	0	universal	nie / no	nie / no	
<b>Asgard 3F</b>	235/95/86 133/196	T3030	T2542	DL	1	universal	nie / no	nie / no	
<b>Dalia</b>	260/95/90 215/145	T25HR foam	T25	DL	1	universal	nie / no	nie / no	
<b>Elise</b>	250/95/90 215/145	HR foam	T25	DL	1	universal	nie / no	nie / no	
<b>Lazaro</b>	245/97/85 195/125	HR+T2540	HR+T2540	DL	1	universal	nie / no	nie / no	
<b>Megis</b>	250/95/90 200/145	HR foam	T25	DL	1	universal	nie / no	nie / no	
<b>Revi</b>	215x98x92 140/200	T35	T35	DL	1	universal	nie / no	nie / no	
<b>Silla</b>	260/104/96 200/145	HR foam/ pocket h-120	puch silikonowy silicone fluff ball	DL	1	universal	nie / no	nie / no	
<b>Silva</b>	236/95/90 200/145	HR foam	T25	DL	-	universal	nie / no	nie / no	
<b>Torrense</b>	195/103/108	HR foam	T2540	-	0	universal	tak / yes	tak / yes	













<b>Bellis</b>	220/90/83 190/110	HR foam/ pocket	HR foam/ pocket	click-clack	1	universal	nie / no	nie / no	
<b>Selene</b>	216/87/93 195/110	T30	T30	click-clack	1	universal	nie / no	nie / no	
<b>Laurence</b>	260/76/99 136/199	Pianka T30 + HR	T25	puma	0	universal	tak / yes	nie / no	

## fotele i szezlongi | armchairs and chaise lounges





model	wymiar (szer./wys./gl.) pow. spania (cm)	wyposażenie (wypełnienie)		regulowany zagiłówek	przesuwne oparcie	materiał, z którego wykonane są nóżki
		siedzisko	oparcie			
model	dimensions (W/H/D) sleeping area (cm)	equipment (filling)		adjustable headrest	sliding backrest	material from which the legs are made
		seat	backrest			

<b>Aros 1F</b>	85/103/90	Pianka Foam T3030	T2542	nie / no	nie / no	
<b>Arti 1F</b>	80/90,5/85	Pianka Foam HR	Pianka Foam T25	nie / no	nie / no	
<b>Asgard 1F</b>	107/86/92	Pianka Foam T3030	Pianka Foam T2542	nie / no	nie / no	
<b>Dalia</b>	105/90/95	Pianka Foam HR	Granulat piankowy Foam granules	nie / no	nie / no	
<b>Lazaro</b>	108/85/89	Pianka Foam HR + T2130	Pianka Foam HR + T2130	nie / no	nie / no	
<b>Megis</b>	102/87/94	Pianka Foam HR 3030	Granulat piankowy Foam granules	nie / no	nie / no	



<b>Silva</b>	93/82/95	Pianka Foam HR 3040	Granulat piankowy Foam granules	nie / no	nie / no			<b>Lara</b>	73/27/73	Pianka Foam HR	0	
<b>Torrense</b>	125/103/113	Pianka Foam HR	Pianka Foam T2540	nie / no	tak / yes			<b>Lazaro</b>	102/40/64	Pianka Foam HR + T2130	0	
<b>Vivien 1F</b>	95,5/85,5/82	Pianka Foam T25	Pianka Foam T25	nie / no	nie / no			<b>Linsy</b>	40/43/40	Pianka Foam HR	0	
<b>Doro szezlong</b>	85/95/170	Pianka Foam HR	Pianka Foam HR	nie / no	nie / no			<b>Lorelle</b>	100/45/70	Pianka Foam HR	1	
<b>Taco szezlong</b>	85/95/170	Pianka Foam HR	Pianka Foam HR	nie / no	nie / no			<b>Monty</b>	70/28/70	Pianka Foam HR	0	
<b>Loren szezlong</b>	85/85/170	Pianka Foam HR	Pianka Foam HR	nie / no	nie / no			<b>Megis</b>	82/42/68	Pianka Foam HR	0	

puffy | pouffes

model	wymiaru (szer./wys./gl.) pow.spania (cm)	wyposażenie (wypełnienie)		pojemnik	materiał, z którego wykonane są nóżki				
		siedzisko							
model	dimensions (W/H/D) sleeping area (cm)	equipment (filling)		container	material from which the legs are made				
		seat							
<b>Asgard</b>	75/45/75		Pianka Foam T3030	0					
<b>Bero</b>	75/42/75		Pianka Foam HR	0					
<b>Kelim</b>	83/42/83		Pianka Foam HR	0					
					<b>Nolla</b>	40/41/40	Pianka Foam HR	0	
					<b>Selene</b>	100/41/70	Pianka Foam T30	0	
					<b>Silla</b>	88/45/68	Pianka Foam HR	0	
					<b>Silva</b>	67/42/67	Pianka Foam HR	0	
					<b>Sofia</b>	45/40/45	Pianka Foam HR	0	
					<b>Torrense</b>	137/45/70	Pianka Foam T3030	0	



## stoliki kawowe | coffee tables

model	wymiary (szer./wys./gl.)	materiał z którego wykonany jest blat	materiał z którego wykonany jest stelaż
model	dimensions (W/H/D)	material from which the table top is made	material from which the frame is made

<b>Cloue</b>	75/41/75	szkło / glass	stal / steel
<b>Linze</b>	75/45/75	szkło / glass	stal / steel
<b>Merala</b>	65/35/65	szkło / glass	stal / steel
<b>Verto</b>	100/45/60	szkło / glass	stal / steel
<b>Clar</b>	75/42/75	drewno Sonoma Sonoma wood	stal / steel
<b>Fresco</b>	60/42/90	plyta Beton, drewno Sonoma, plyta Biały Mat / concrete slab, Sonoma wood, white matte slab	stal / steel
<b>Gavino</b>	60/42/90	plyta Beton, drewno Sonoma, plyta Biały Mat / concrete slab, Sonoma wood, white matte slab	stal / steel
<b>Lupe</b>	75/46/75	plyta Sonoma Sonoma slab	stal / steel
<b>Moss</b>	65/36/65	plyta Sonoma Sonoma slab	stal / steel
<b>Marlo</b>	100/48/60	plyta Sonoma Sonoma slab	stal / steel

<b>Nevio</b>	69/39/69	plyta Beton, drewno Orzech Burgundia drewno Orzech Burgundia/ plyta Beton concrete slab, Burgundia nut wood, Burgundia nut wood / concrete slab	stal / steel
<b>Torvi</b>	100/59/60	plyta Sonoma Sonoma slab	stal / steel
<b>Vigo</b>	45/67/45	plyta Sonoma Sonoma slab	stal / steel
<b>Vince</b>	100/46/60	plyta Sonoma Sonoma slab	stal / steel

## lustra dekoracyjne | decorative mirrors

model	wymiary (szer./wys./gl.)	materiał, z którego wykonana jest rama
model	dimensions (W/H/D)	material from which the frame is made

<b>Arizona</b>	40/130/3	Płyta MDS MDS slab
<b>Verona</b>	50/170/5	Płyta MDS MDS slab
<b>Aruba</b>	65/175/3	Płyta MDS MDS slab
<b>Medina</b>	60/160/4	Płyta MDS MDS slab
<b>Vasto</b>	60/140/6	Płyta MDS MDS slab



meble twarde - Avorio | storage furniture and tables - Avorio

meble twarde - Lanzzi | storage furniture and tables - Lanzzi

model	wymiary (szer./wys./gl.)	wykończenie frontu	wykończenie korpusu	materiał, z którego wykonany jest stelaż	kolor	liczba szuflad	liczba drzwiczek
model	dimensions (W/H/D)	front finish	body finish	material from which the frame is made	colour	number of drawers	number of doors
<b>stoliki nocne</b> bedside tables	40/60/40	biały połysk czarny połysk white polish black polish	drewno / wood	stal / steel	dąb artisan dąb artisan /czarny połysk dąb artisan /biały połysk aristan oak aristan oak/black polish aristan oak/white polish	1	0
<b>komody</b> chests of drawers	120/80/40 180/80/40	biały połysk czarny połysk white polish black polish	drewno / wood drewno / wood	stal / steel stal / steel	dąb artisan /czarny połysk dąb artisan /biały połysk aristan oak/black polish aristan oak/white polish	1 2	2 2
<b>stoliki kawowe</b> coffee tables	60/40/60	biały połysk czarny połysk white polish black polish	-	stal / steel	biały połysk czarny połysk white polish black polish	0	0
<b>konsole</b> consoles	40/80/120	biały połysk czarny połysk white polish black polish	drewno / wood	stal / steel	dąb artisan /czarny połysk dąb artisan /biały połysk aristan oak/black polish aristan oak/white polish	2	0
<b>szafki RTV</b> TV cabinets	40/50/120	biały połysk czarny połysk white polish black polish	drewno / wood	stal / steel	dąb artisan /czarny połysk dąb artisan /biały połysk aristan oak/black polish aristan oak/white polish	1	0
<b>szafy i witryny</b> wardrobes and showcases	60/200/120 40/140/200	biały połysk czarny połysk white polish black polish	drewno / wood	stal / steel stal / steel	dąb artisan /czarny połysk dąb artisan /biały połysk aristan oak/black polish aristan oak/white polish	0	3 2

model	wymiary (szer./wys./gl.)	wykończenie frontu	wykończenie korpusu	materiał, z którego wykonany jest stelaż	kolor	liczba szuflad	liczba drzwiczek
model	dimensions (W/H/D)	front finish	body finish	material from which the frame is made	colour	number of drawers	number of doors
<b>stoliki nocne</b> bedside tables	40/50/40	drewno czarny mat wood black matt	czarny mat black matt	stal steel	czarny mat / dąb artisan czarny mat black matt / aristan oak black matt	1	0
<b>komody</b> chests of drawers	120/80/40 180/80/40	drewno czarny mat wood black matt	czarny mat black matt czarny mat black matt	stal steel stal steel	czarny mat / dąb artisan czarny mat black matt / aristan oak black matt	1 1	1 2
<b>stoliki kawowe</b> coffee tables	60/40/60	drewno czarny mat wood black matt	czarny mat black matt	stal steel	czarny mat / dąb artisan czarny mat black matt / aristan oak black matt	0	0
<b>półki wiszące</b> hanging shelves	120/20/25	drewno czarny mat wood black matt	czarny mat black matt	-	czarny mat / dąb artisan czarny mat black matt / aristan oak black matt	0	2
<b>szafki RTV</b> TV cabinets	40/50/120	drewno czarny mat wood black matt	czarny mat black matt	stal steel	czarny mat / dąb artisan czarny mat black matt / aristan oak black matt	0	2
<b>szafy i witryny</b> wardrobes and showcases	135/200/60 120/200/60 120/150/40	drewno czarny mat wood black matt	czarny mat black matt	stal steel	czarny mat / dąb artisan czarny mat black matt / aristan oak black matt	3 2 2	3 2 2



# piktogramy - legenda

## pictograms - legend



**mebel dostępny w wersji prawej i lewej**  
piece of furniture available as left-sided and right-sided

**typ mechanizmu rozkładania** | type of folding mechanism



**delfin**  
dolphin



**DL**  
DL



**puma**  
puma



**click-clack**  
click-clack

**materiał, z którego wykonane są nóżki** | material from which the legs are made of



**metal**  
metal



**drewno**  
wood



**chrom, tworzywo sztuczne**  
chrome, plastic



**regulowane zagłówki**  
adjustable headrests



**przesuwne oparcia**  
sliding backrests



**powierzchnia spania**  
sleeping surface



**pojemnik na pościel**  
bedding container



**szeroka gama kolorystyczna**  
lots of colours

# sieć dystrybutorów

## distributor network

**Zostań naszym dystrybutorem**

W ELTAP stawiamy na jakość, profesjonalizm, odpowiedzialność i zaufanie. Dlatego zachęcamy do zostania naszym dystrybutorem. Decydując się na współpracę z ELTAP, masz pewność, że Twoi klienci otrzymają na czas towar najwyższej jakości. Dodatkowo oferujemy narzędzia wspierające sprzedaż i promocję. Każdy segment współpracy zawiera zestaw odpowiednich narzędzi marketingowych, które ułatwiają dystrybucję naszych produktów.

Oferujemy także materiały poradnikowe i dzielimy się naszym doświadczeniem zebranych w czasie długoletniego istnienia firmy w branży meblarskiej. Zapraszamy do współpracy z ELTAP!

**Become our distributor!**

At ELTAP, quality, professionalism, responsibility and trust are of special importance, which is why we encourage you to become our distributor. By deciding to cooperate with ELTAP, you can be assured that your customers will receive the highest quality goods on time. For this purpose, we provide the right tools to support sales and promotion. Each segment of cooperation includes a set of appropriate marketing tools that facilitate the distribution of our products. We also offer guidance materials and share the experience gained during the long-term existence of our company in the furniture industry. We warmly invite you to cooperate with ELTAP!





Skontaktuj się z nami | Contact us:

Dział Obsługi Klienta /Customer Service Department

 [office@eltap.com](mailto:office@eltap.com)

 600 700 400

ELTAP Spółka z ograniczoną odpowiedzialnością Sp.k.

63-604 Baranów

Mroczeń 203

NIP: 6192050823